



CATÁLOGO GENERAL



SICAFUR, S.L es una empresa dedicada a la comercialización de suministros y soldaduras especiales, dirigido a empresas y profesionales de ámbito industrial.

Nuestro objetivo es que los clientes sean nuestros compañeros de viaje y ser una extensión más de su empresa, ayudándolos en todo momento para conseguir un crecimiento conjunto.

Nuestro personal cuenta con experiencia en el sector tratando de conseguir un firme objetivo, procurar el mejor servicio a nuestros clientes, contando con una amplia gama de productos disponibles en nuestro almacén para garantizar entregas oportunas y rápidas.

Trabajamos con fabricantes de primer nivel nacional e internacional con un programa de suministros que alcanza miles de referencias en stock. Gracias a nuestra propia red de comercialización y distribución, es como damos un servicio excepcional a nuestros clientes.

Disponemos de gestores comerciales especialistas preparados para prescribir los mejores productos a los precios más competitivos del mercado. Atendemos las necesidades particulares de cada cliente, nos desplazamos a su puesto de trabajo para un asesoramiento personalizado y seguimiento post venta. Además, el equipo comercial está formado en todos los ámbitos industriales, conocen el producto, y saben qué es lo más adecuado y con mayor rendimiento para cada tarea.

En la tienda recibirá una atención personalizada, donde nuestro personal le ayudará y le asesorará a encontrar todo aquello que necesite. Si hay algún producto que no esté disponible en nuestra tienda, se lo conseguimos.

A continuación, les presentamos nuestro catálogo que tienen su fundamento en un estudio detallado de los productos industriales de mayor y más habitual consumo en el sector industrial.





PETRONAS



ESPECIALISTAS EN RODAMIENTOS, DISTRIBUIDORES OFICIALES.

Rodamientos de bolas, rodamientos de agujas, rodamientos de rodillos cilíndricos, soportes para rodamiento, rótulas, coronas de giro, casquillos de fricción.

¿Necesita un rodamiento y tiene alguna duda?
Permítanos ayudarle a encontrar la mejor solución.



SOPORTES+RODAMIENTO INOXIDABLE



SOPORTES

Los soportes para rodamiento se fabrican en múltiples diseños y materiales en función de su campo de aplicación.

Se suministran con un rodamiento provisto de un aro exterior esférico que tiene libertad para oscilar en la pista del soporte, de manera a compensar cualquier defecto de alineación y eliminar todo posible esfuerzo entre el eje y el propio soporte

Tipos de materiales:

Acero de fundición, de aluminio, chapa de acero estampado, completamente inoxidable y de poliamida o termoplástico.



CASQUILLOS AUTOLUBRICADOS



ROTULAS





RODAMIENTOS



SOPORTES



RÓTULAS

Las **rótulas** son componentes mecánicos orientables que permiten la transmisión de fuerzas estáticas y dinámicas conjuntamente con los movimientos de alineación oscilantes, rotativos y de inclinación en varias direcciones. Están disponibles en superficies de contacto de acero/acero y muchas otras soluciones que no precisan mantenimiento. Las **cabezas de articulación** están formadas por un cuerpo o alojamiento en forma de ojo en el que va insertado una rótula de forma permanente. Están disponibles con roscas a izquierdas o a derechas, interna (hembra) o macho (externa).



RODAMIENTOS Y GUIAS LINEALES

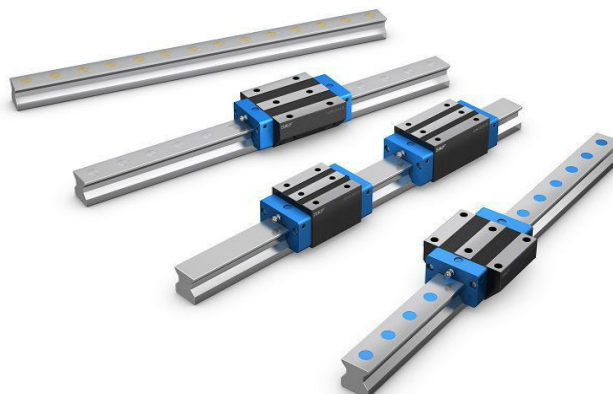

RODAMIENTOS

FAG



SOPORTES

FAG





RODAMIENTOS



RODAMIENTO PATIN Y GUIAS

HIWIN



Rexroth
Bosch Group

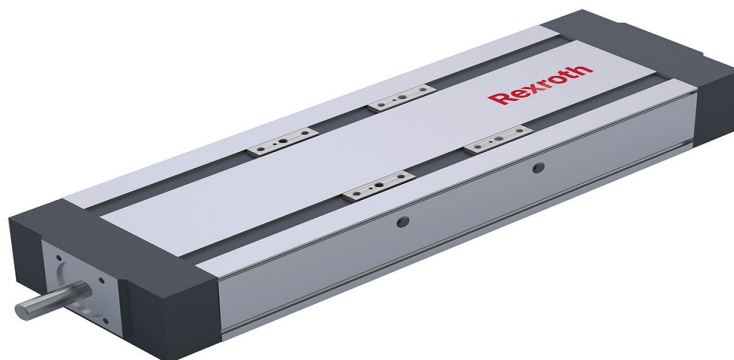

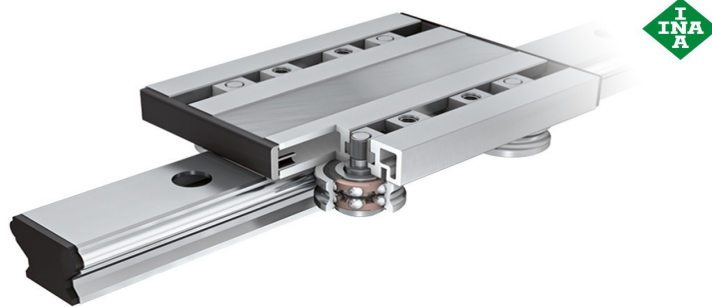

La División de **Movimiento Lineal** de está dedicada exclusivamente al asesoramiento y comercialización de componentes, unidades y sistemas para movimientos lineales aportando soluciones para sistemas de guiado, de accionamiento, actuación y posicionado.

ISB amplía su gama de productos incluyendo los sistemas de movimiento lineal, que destacan, entre otros factores por la intercambiabilidad* de las guías y patines con otras marcas del mercado

- Guías lineales y patines compatibles con ABBA, SKF : ISB-as
- Guías lineales y patines compatibles con STAF, SNR: ISB-s
- Guías lineales y patines compatibles con TBI: ISB-tb
- Guías lineales y patines compatibles con HIWIN: ISB-h

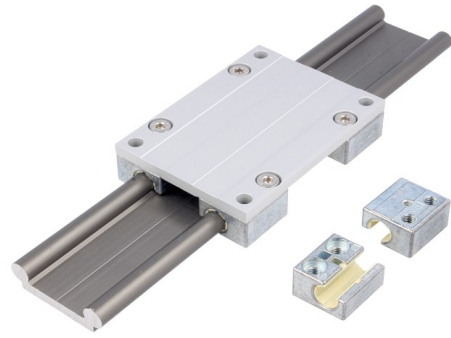



Los **manguitos** son utilizados para el bloqueo de los rodamientos con agujero cónico en los ejes cilíndricos. Tienen forma cónica y están cortados longitudinalmente para adaptarse mejor a las dimensiones del agujero del rodamiento (conicidad 1:12). Simplifican el montaje y el desmontaje de los rodamientos y el diseño de las máquinas. Permiten tolerancias más holgadas entre eje y rodamiento.

MANGUITOS



TUERCAS KM



ARANDELA MB

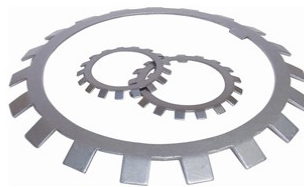

RODAMIENTOS HORNO

Los rodamientos y las unidades de rodamientos para altas temperaturas están diseñados para proporcionar una mayor confiabilidad, menor complejidad y un menor impacto

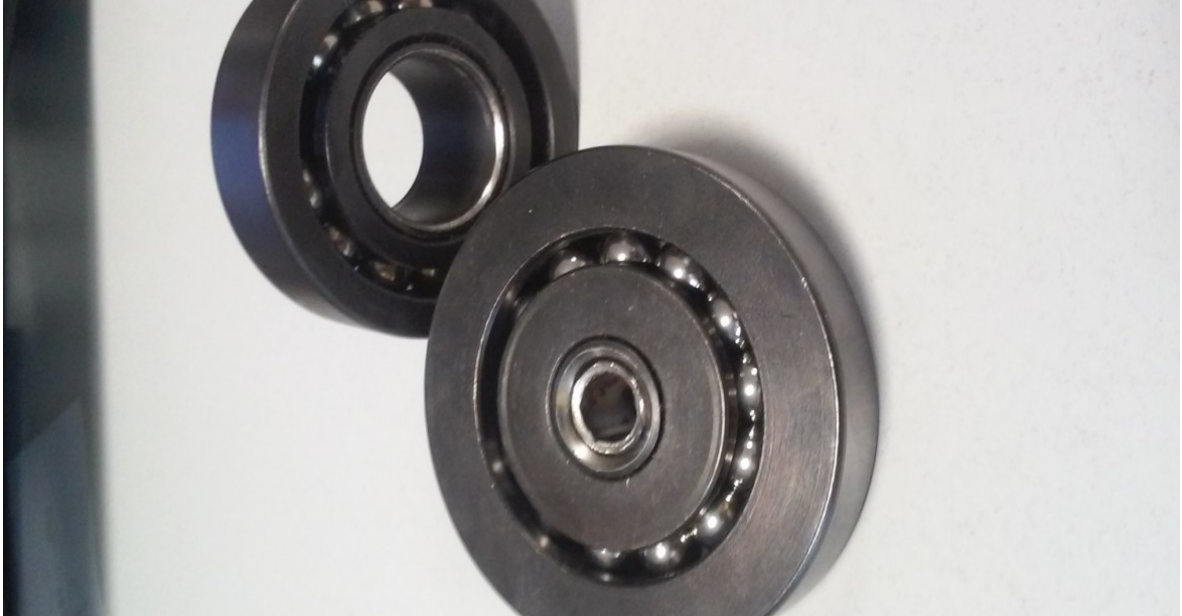

medioambiental en **temperaturas de funcionamiento de hasta 350 °C (660 °F)**, lo que los convierte en productos muy adecuados para aplicaciones de hornos. Debido a que los rodamientos para altas temperaturas corresponden a las dimensiones ISO de los rodamientos lubricados con grasa, se puede lograr la eficacia en la producción y ahorrar costos.





RETENES Y JUNTAS TORICAS

Se trata de **juntas de estanqueidad** para aplicaciones hidráulicas y neumáticas cuya función principal es estanqueizar el vástago o el pistón de los cilindros. Son piezas elastoméricas en forma de U con diferentes diseños, geometría y materiales. Pueden suministrarse en medidas y materiales especiales (consulte nuestra Oficina Técnica sin compromiso)



Los **retenes** son **juntas técnicas** para ejes rotativos. Se fabrican en una gran variedad de formas y materiales, según las condiciones de trabajo y debe ser cuidadosamente examinado antes de decidir su empleo para asegurar un funcionamiento duradero. El presente catálogo recoge diferentes propuestas para la elección de un retén estándar para una aplicación genérica.



SOLDADURA LASTEK

Todo tipo de **accesorios para soldar**. Equipos, electrodos de soldadura, alambres y varillas de soldadura... Todos los materiales y accesorios posibles los tienes aquí. Con ellos podrás realizar cualquier trabajo de fijación de metales. Disponemos de **los mejores accesorios y herramientas para soldar** al mejor precio. ¡Consúltanos para obtener más información al respecto!



EQUIPOS DE SOLDADURA Y TIG





Distribuidores oficiales de Klingspor, uno de los principales fabricantes del mundo de productos de alta calidad para el mecanizado de superficies y el corte de materiales.



CORREAS

Correas industriales de caucho, poliuretano de fabricación especial recubiertas.

Nuestros productos principales son los siguientes:



- Correa Trapecial
- Correa Dentada de Caucho
- Correa Poly-V
- Correa Dentada de Poliuretano



CORREA TERMOSOLDABLE

Revestimiento vulcanizado de ruedas y rodillos. Recubrimiento y recubrimiento en frío de ruedas y rodillos. Realiza detalles de diseño en Reatec, Poliuretano, Oldopren, Silicona, Vaiton, Urepan y otros compuestos especiales. Nuestra gama de productos también incluye: Cintas transportadoras en Caucho, P.V.C., Poliuretano y corte con superficie rectificada. Cintas termosellables de poliuretano para transporte, con o sin refuerzo interno y revestimiento alveolar en Caucho, Poliuretano y Silicona. Equipo para el montaje de cintas transportadoras termosellables.

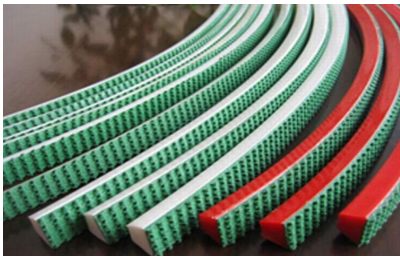

CORREA POWERTWIST

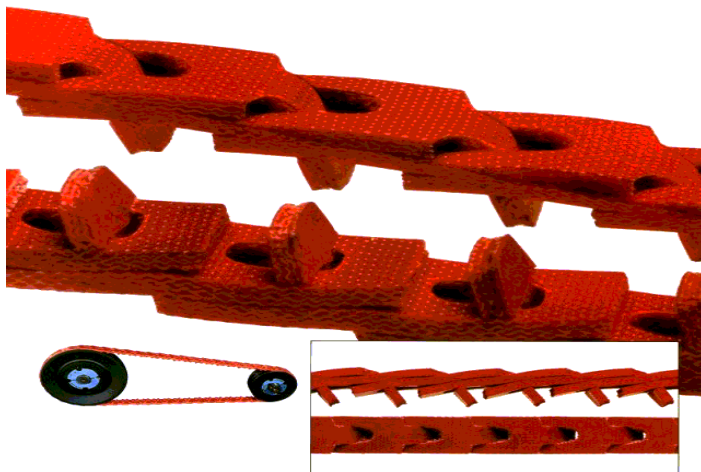

CORREA BRECO CON RECUBRIMIENTO LINATEX

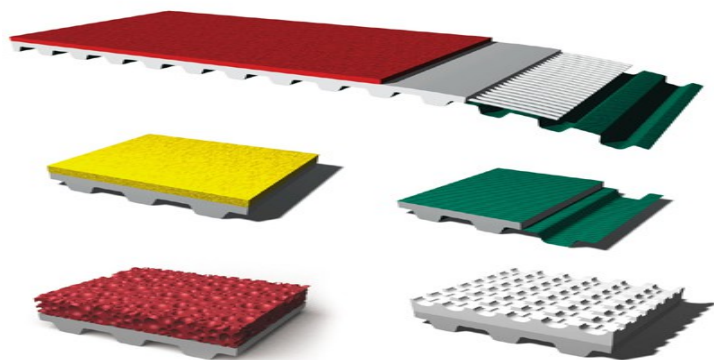

CORREA CON PELO

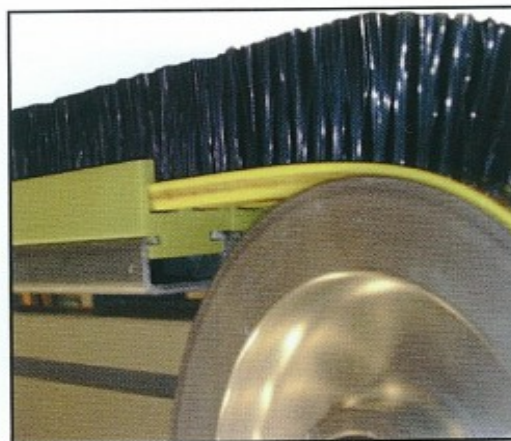
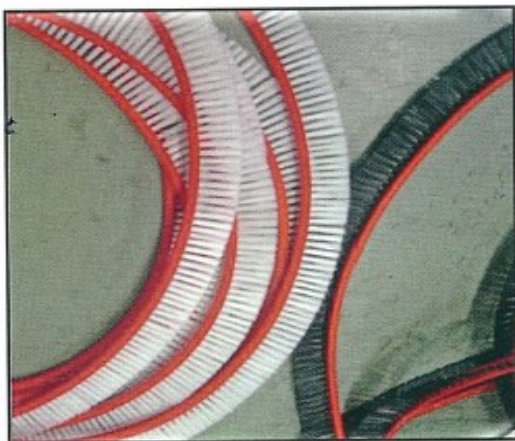

UTENSILIOS PARA UNIR CORREAS



CADENA DE TRANSMISIÓN

Distribuidor oficial de Sugiyama, cadena japonesa de transmisión para la industria, cadenas con aletas y cadenas de transporte de gran tamaño. Productos complementarios tales como Ruedas libres, piñones, acoplamientos, mecanismos de seguridad, Bujes cónicos, poleas completan nuestra gama de producto. Podemos ensamblar cadenas con aletas ahorrando tiempo a nuestros clientes y garantizando una optima calidad. En caso de necesidades especiales, podemos fabricar cadenas especiales bajo pedido.



SUGIYAMA

RENOLD
Superior Chain Technology

Innovation in Motion
TSUBAKI

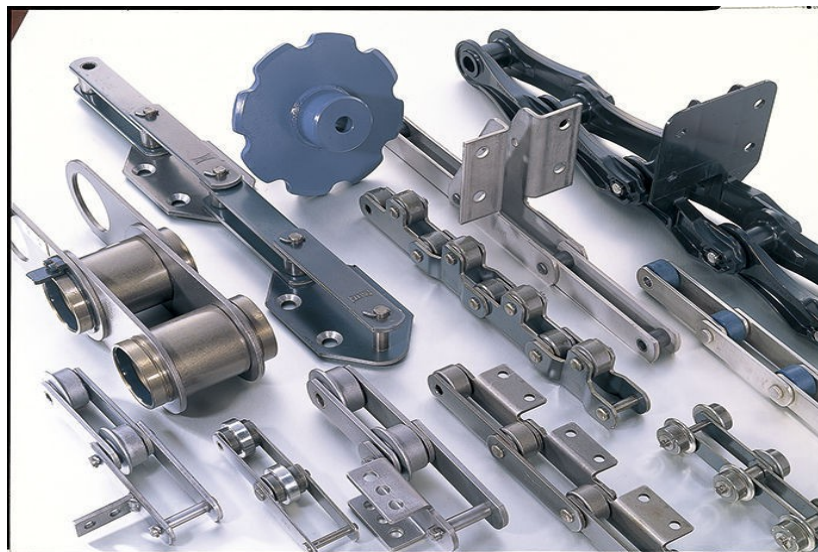

POLEAS, PIÑOS Y BUJES CÓNICOS



CIERRES MECÁNICOS

T ROTEN



MOTOTAMBORES Y RODILLOS



MOTORES Y REDUCTORES

Motores eléctricos diseñados conforme a las especificaciones y normativas Europeas e Internacionales.

Disponemos de un amplio stock de toda la gama en nuestros almacenes.
Además de todos los recambios y bridas sueltas para su adaptación.



ABB

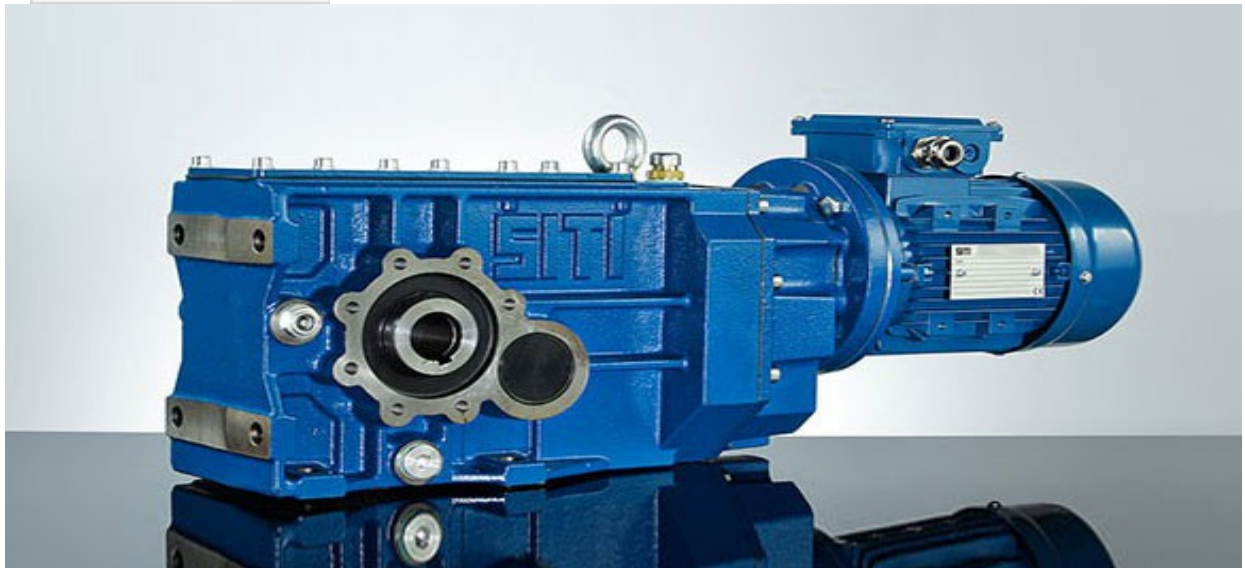

BOMBAS CENTRÍFUGAS



ACOPLAMIENTOS



samiflex®



CADENAS ROBÓTICAS



PERFILES APM Y POLIGUR

Trabajamos con fabricante directo dedicado a la inyección de termoplásticos, fabricación y comercialización de guías de deslizamiento y piezas técnicas con mecanizado mediante CNC de tres y cinco ejes. Así mismo trabajamos con láminas y planchas en polietileno y polipropileno de primera calidad, productos cuyas propiedades los convierten en materiales con múltiples aplicaciones. También realizamos trabajos personalizados y a medida, así como corte por láser en metacrilato y otros materiales.

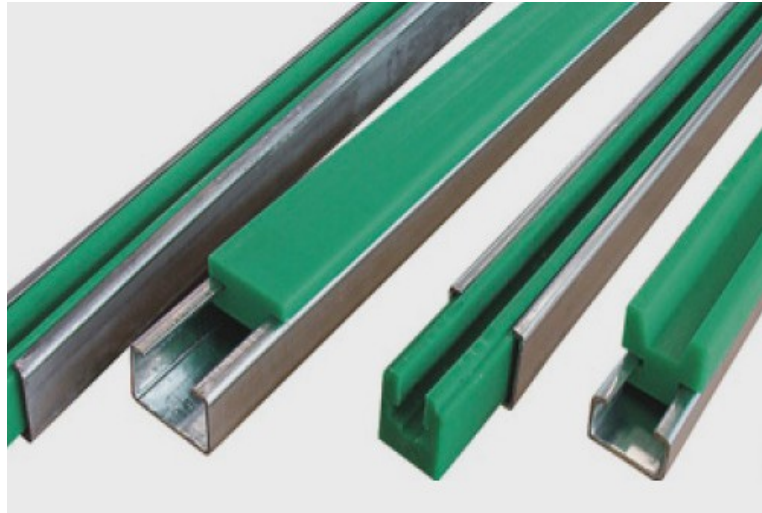

VULCANIZADO POLIURETANO



PRESORES



SOPORTES ANTIVIBRANTES



Los soportes antivibratorios de muelle VT de AMC MECANOCAUCHO® están diseñados para aislar la vibración de la maquinaria suspendida en entornos industriales o para el montaje de falsos techos acústicos.



ADHESIVOS Y MULTISPRAYS

LOCTITE® es la marca líder mundial en adhesivos, selladores y productos para el tratamiento de superficies. Con una tecnología de lo más avanzada, brindamos soluciones que satisfacen nuestros objetivos al proporcionar unos adhesivos más eficientes que son a la vez resistentes, fuertes y duraderos para liberar el potencial ilimitado del hombre y la máquina. Conoce más sobre nuestra extensa gama de productos para las aplicaciones industriales más exigentes.

LOCTITE





Especializada en cintas técnicas y soluciones adhesivas para el sector industrial, profesional y de bricolaje.





Líderes en el diseño, fabricación y distribución de productos de inyección de plástico para uso profesional.



Escaleras y andamios para uso profesional, industrial y doméstico. ¡Precios de fábrica! , fabricantes de todo tipo de escaleras y andamios. Infórmese sin compromiso. Escaleras a medida. Escaleras telescópicas. Escaleras retráctiles. Calidad garantizada.





LUBRICANTES



ABRAZADERAS

MIKALOR



TORNILLERÍA



TORGLOBAL

MAYOR DE TORNILLOS

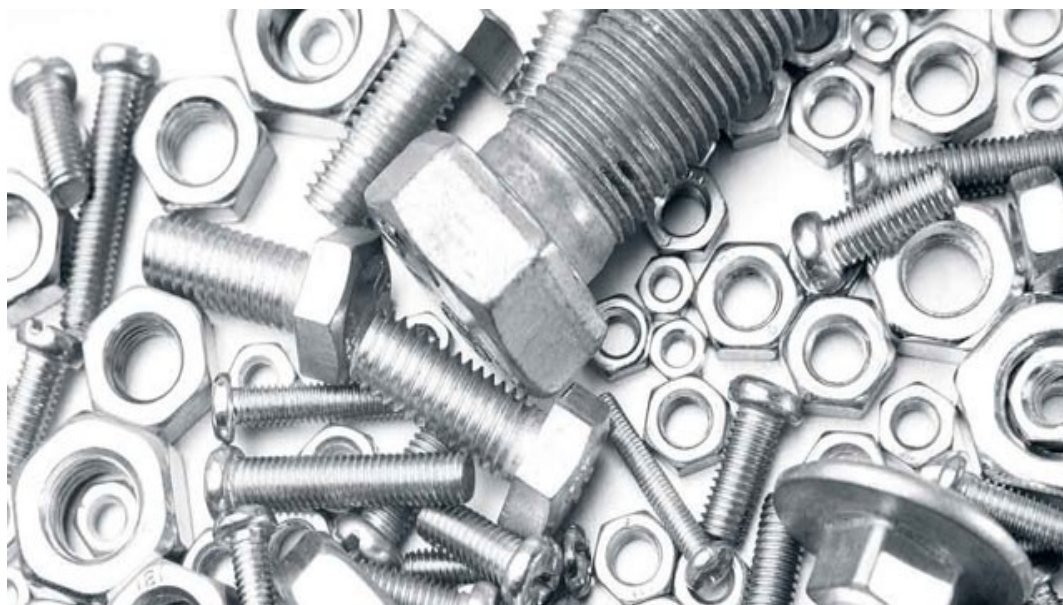

RACORERÍA NEUMÁTICA



VÁLVULAS



GUILLEMINES GALVA/INOX



INSTRUMENTOS DE VERIFICACIÓN Y CONTROL

Instrumentos de medición, trazado y verificación como micrómetros, dinamómetros, palpadores, niveles, mirafondos, goniómetros, alesómetros,...



HERRAMIENTA

Distribuidor oficial de **Beta Iberia**, fabricante de **herramientas manuales**. Especialistas en **llaves**, **destornilladores**, **alicates**, **martillos**, **herramientas de medición**, **linternas**, entre otras.



BROCAS Y MACHOS

Hepyc, empresa especializada en el diseño, fabricación y comercialización de herramientas de corte tales como Brocas, Machos de roscar, fresas, ...



SIERRAS CINTA

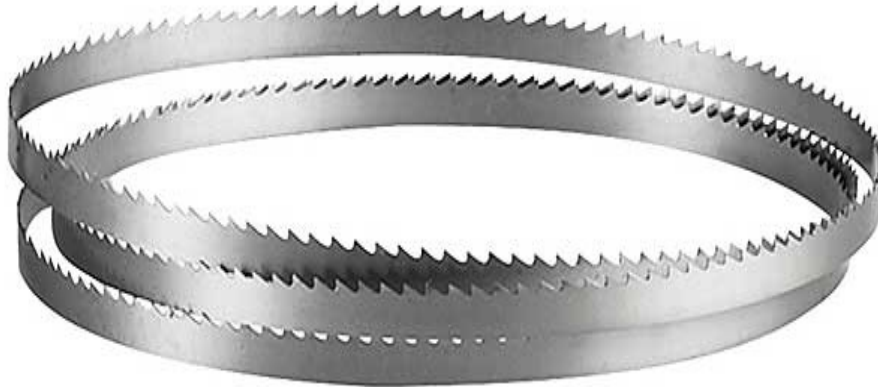

FABRICACIÓN DE LATIGUILLOS

Fabricamos latiguillos, racores y cualquier elemento para la unión de los distintos componentes de los sistemas hidráulicos y neumáticos.



ATOMIZADOR

Modello
Type **E500**



Ugello atomizzatore per spray dryers MODELLO E 500 Spray nozzle for spray dryers TYPE E 500

- E 501.030 - Contenitore con attacco 3/8 Gas
Holder with connection 3/8 Gas
- E 501.031 - Contenitore con attacco 3/4 Gas
Holder with connection 3/4 Gas
- E 501.032 - Distributore
Core central
- E 501.004 - Placchetta senza foro
Unbored plate
- E 501.006 - Placchetta forata F = 0,8 ÷ 5 Ø19
Bored plate F = 0,8 ÷ 5 Ø19
- E 503.037 - Placchetta forata F = 0,8 ÷ 5 Ø14
Bored plate F = 0,8 ÷ 5 Ø14
- E 504.020 - Placchetta DIAMANTATA "Carbonium" forata F = 0,8 ÷ 5
Bored plate DIAMOND TYPE "Carbonium" F = 0,8 ÷ 5
- E 501.033 - Chiocciola 1 via con turbolenza $\neq 2 \div 12$
Swirl chamber 1 way $\neq 2 \div 12$ turbulence
- E 502.034 - Chiocciola 3 vie cilindrica con turbolenza $\neq 2 \div 7$
Cylindric swirl chamber 3 ways $\neq 2 \div 7$ turbulence
- E 503.035 - Chiocciola 3 vie conica con turbolenza $\neq 2 \div 7$
Conical swirl chamber 3 ways $\neq 2 \div 7$ turbulence
- E 501.036 - Testata

New

CENTRADORES DE BANDAS TRANSPORTADORAS PARA ATOMIZADORES

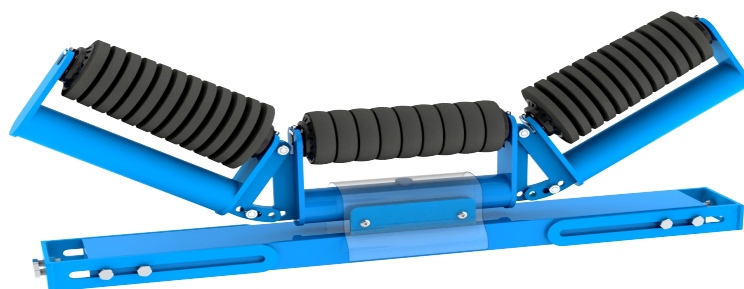
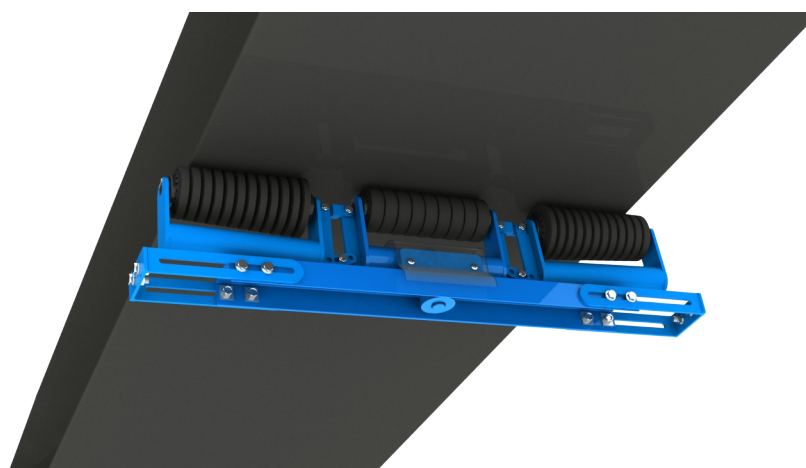
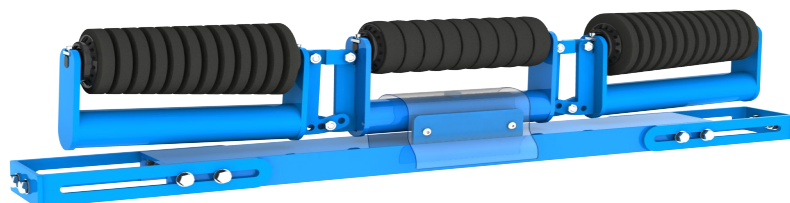

RASCADORES PARA BANDAS TRANSPORTADORAS

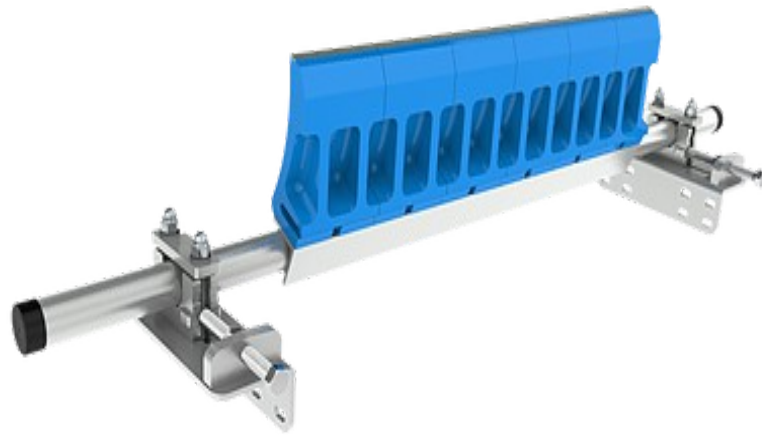

BOMBAS FLSMIDTH



EQUIPOS DE PROTECCIÓN INDIVIDUAL



En **J'hayber Works** contamos con calzado de seguridad y ropa de de trabajo al mejor precio. Zapatos y ropa de trabajo fabricado en Alicante. Descúbrelo.



3L Internacional: Material de seguridad, EPIs, guantes, proteccion visual, auditiva, protección de cabeza



Irudek: especialistas en mascarillas y líneas de vida.



VENTILACIÓN INDUSTRIAL



LIMPIEZA INDUSTRIAL

Amplia gama de productos químicos dedicados a la limpieza industrial, abrillantadores, deastascadores, jabón o pasta lavamanos, bobinas de celulosa, trapos...así como refrigerantesm aguas destiladas, taladrinas, consultanos!



CEPILLOS INDUSTRIALES

Fabricación de todo tipo de cepillo industrial y a medida.



MANGUERA



BOSPHORUS



TROY LD



TROY SLD



TROY ST SE
ELASTIC



OLYMPOS



PARARUB SDC

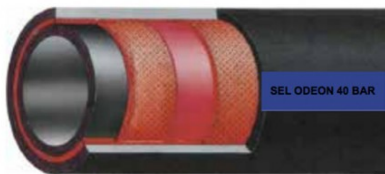

ODEON 40
BAR



EGE 10



AIR LONG
KOM

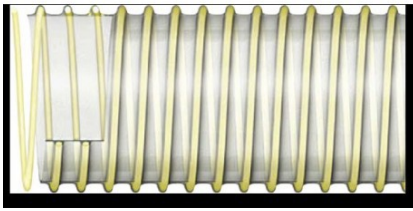

EOLO PU

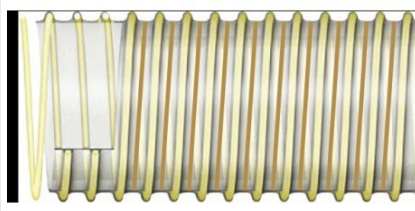

EOLO PU
ANTIESTATICA



EOLO TERMO



GORDION



JUPITER



ODEON 20 BAR

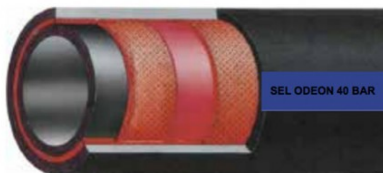

ODEON 40
BAR

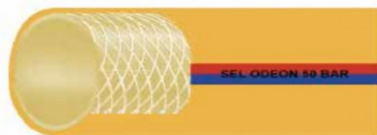

ODEON 50 BAR

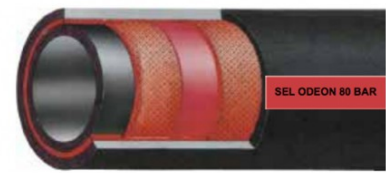

ODEON 80
BAR

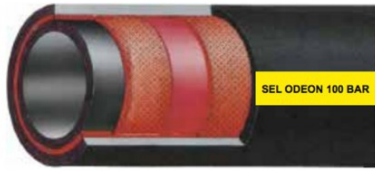

ODEON 100 BAR

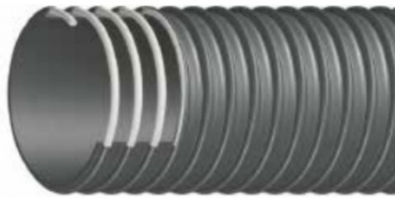

URARTU



VULCANO TPR



VULCANO PUZ



FORCESTREAM
1SN

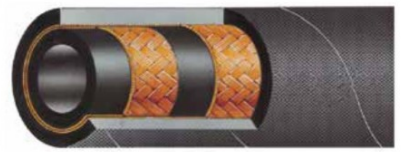

FORCESTREAM
2SC

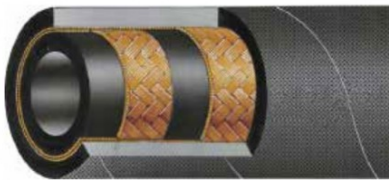

FORCESTREAM
2SN

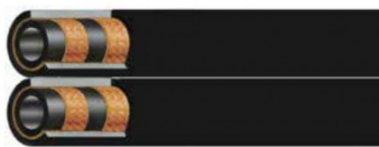

TWINSTREAM
2SC

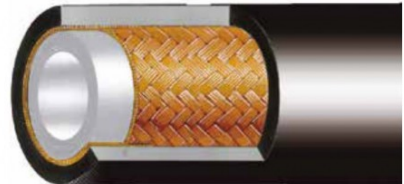

SELSTEEL
1MALLA
METALICA

TUBO FERRAR RODILLOS



TYGON



PLANCHA

Planchas para baberos y recubrimientos antidesgaste. Resistentes a la abrasión y al impacto. Alimentación. Planchas certificadas .



LOC LINE



LOC-LINE
THE ORIGINAL MODULAR HOSE SYSTEM



1/4" Double Socket 1/2" Double Socket



1/4" NPT Connector 1/8" NPT Connector 1/2" NPT Connector 3/8" NPT Connector



1/4" Y Connector 1/2" T Fitting



1" Flare Nozzle For 1/4" Hose 1/4" Round Nozzle 1/4" Swivel Nozzle 1/2" to 1/4" Adapter 1/4" 90 Degree Spray Bar Nozzle



1/4" In-Line Valve 1/4" Elbow Fitting



1/4" Loc-Line Hose Kit 13"
2pcs 5 3/4" Hose | 1/4", 1/8" & 1/16" Nozzle Tips
1/4" & 1/8" NPT Fittings



1/4" Loc-Line 5-3/4" Long

1/2" Loc-Line 5-1/2" Long

1/2" Hose Assembly Pliers
1/4" Hose Assembly Pliers

TECNODIN



Fabricación de elementos de accionamiento y maniobra contamos con una amplia gama de pomos, asas y volantes de baquelita, palomillas en termoplastico, empuñaduras graduables, tornillos de nylon y otros productos para la industria.



HERRAMIENTA NEUMÁTICA

ADIA



EQUIPOS DE ENGRASE



TACOS FICKERT



1

FIKERT RESINOIDE DIAMANTATO
Z17 140 mm



2

FIKERT RESINOIDE DIAMANTATO
Z12 100 mm



3

FIKERT RESINOIDE DIAMANTATO
Z09 140 mm



4

FIKERT RESINOIDE DIAMANTATO
PIENO 140 mm



5

FIKERT RESINOIDE SATINANTE
140 mm



6

SPAZZOLA FIKERT SIC
140 mm



7

SPAZZOLA FIKERT DIAMANTATA
140 mm



8

SPAZZOLA TAMPICO
Ø 150 mm



9

SATELLITE FELTRO
150/22



10

SATELLITE FELTRO
150/50



11

SATELLITE FELTRO
150/80



12

SATELLITE FELTRO LAMELLARE
150/80

MAQUINAS Y CEPILLERIA

AEG



FECIN
cepilleria industrial s.a.



IMANES

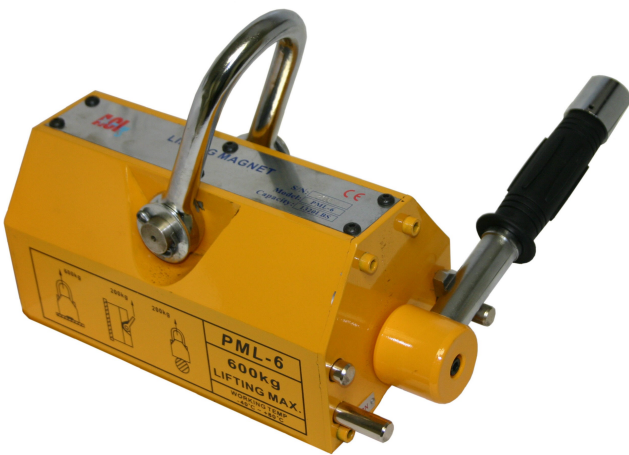
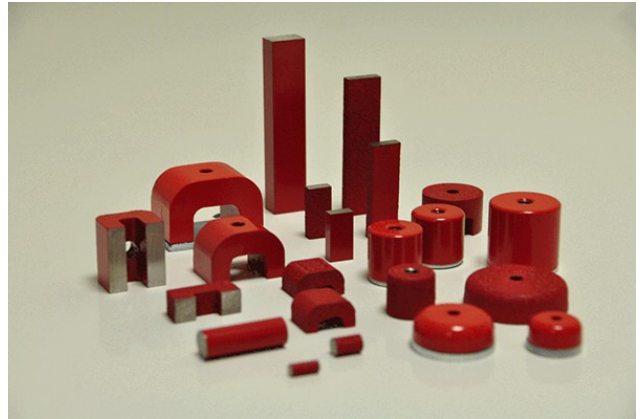

[SICAFUR]

Suministros Industriales



**P.I Les Forques, Monteblanco
c/Asunción 2, Onda (Castellón)
12200**

964-91 91 99/ 603 81 01 68

sicafur@sicafur.com